

USER MANUAL



Thank you for choosing Better Bathrooms.
Please read this manual before installing your product
and keep for future reference.

**better
bathrooms**

Back to Wall Toilet

- Toilet seat and cistern sold separately
- Waste pipe sold separately if a new installation

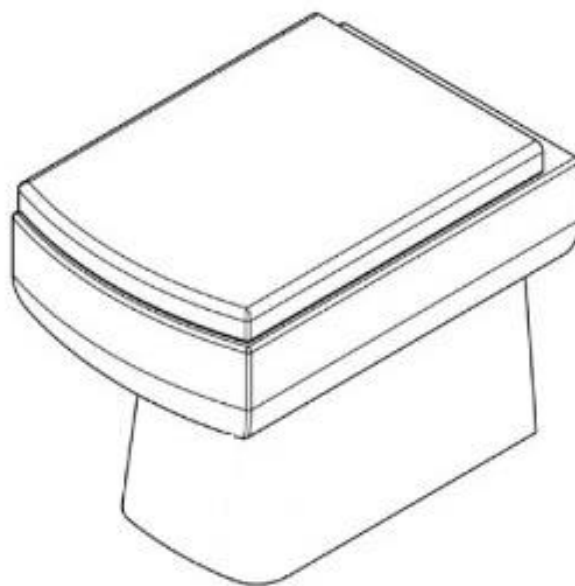

Please note: Image is for illustrative purposes only and may differ slightly to the actual product

- **Single-person assembly**
- **Tools required**
- **We always recommend using professional tradespeople to install your product**

V2 1.12.20

Congratulations on your purchase

And welcome to our growing gang of savvy shoppers

We're on a mission to bring you extraordinary bathroom products, for less. From modern to traditional style ceramics, plus the gorgeous fixtures, fittings and furniture to match. So, you can fall in love with your space every single day.

As one of the UK's largest independent bathroom stores, we've received countless awards; including the National Business Awards UK, the Digital Entrepreneur Awards and being placed on The Sunday Times Fast Track 100.

We hope your new product exceeds your highest expectations. However, if you experience any problems, please:

- call our friendly UK call centre on **0330 390 3062** (9am-7pm Monday to Friday, or 10am-4pm Saturday and Sunday), or
- send us a message via **customerservices@buyitdirect.co.uk**

Important information

- Please read these instructions thoroughly and retain for future reference.
- Manufactured to BS EN997 WC pans and WC suites with integral trap.
- All installation work must be carried out to comply with the Water Bylaw Regulations.
- The installation should be designed to allow access for maintenance.
- This manual covers installation of the toilet pan only - Unit, seat and cistern are NOT supplied.



Contents

• Parts	4
• Tools required	4
• Installation	
○ Preparing for Back to Wall Toilet Pan Fitting	5
○ Back to Wall Toilet Pan Fitting	6-8
• Troubleshooting	9
• Maintenance	9
• Cleaning	9

Parts

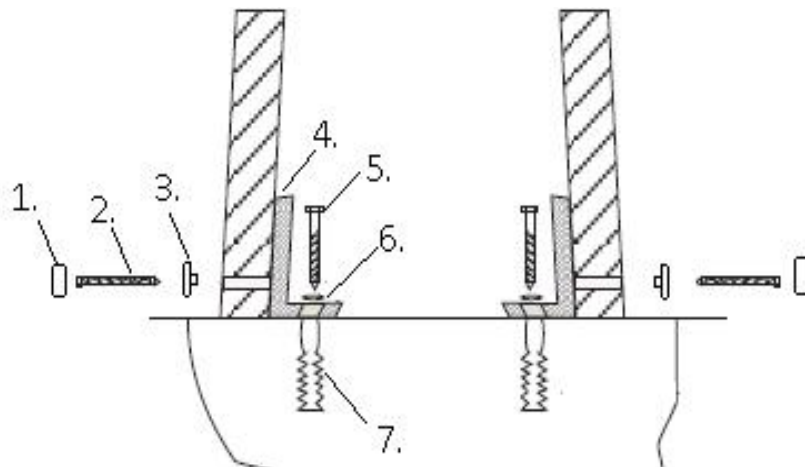

Toilet Pan

Floor fixing kit (below components)

1. Screw cover
2. Bracket to pan fixing screw
3. Screw cup
4. Floor fixing 'L shaped' bracket
5. Floor screw
6. Screw washer
7. Screw plug

Please Note: For toilets which secure through the toilet directly into the floor, the 'L shaped' bracket is not used

Tools required

- Screwdriver
- Pencil
- Drill
- Spirit Level
- Drill Bit
- Hacksaw
- Spanner

Installation

Please note: Before starting any installation, turn off the water supply

Please note: Whenever possible and when safe to do so, it is recommended to carry out leak tests during the installation process

Preparing for Back to Wall Toilet Pan Fitting

A – Flush pipe is supplied with the concealed cistern assembly, (cistern sold separately).

B – Pan connector (waste pipe) may need to be purchased separately if a new installation.

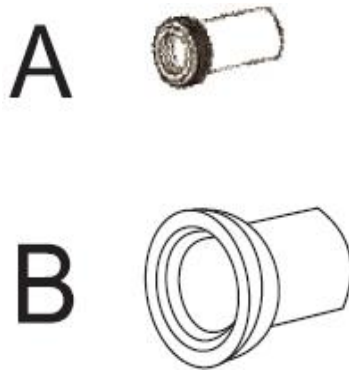

Please note: Pipes are not included.

Once you have received your toilet pan, this will allow you to prepare and install the cistern and WC unit (both sold separately). To install the cistern and WC unit, please use the instruction guides supplied with them.

This guide advises on installation of the back to wall toilet pan only.

Below example shows the assembly of a concealed cistern and WC unit prior to fitting the back to wall toilet pan.

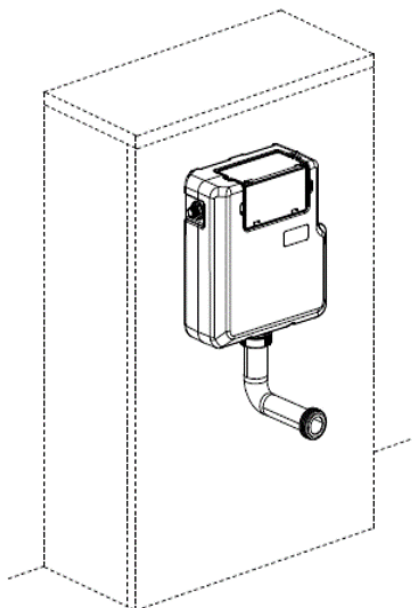

Back to Wall Toilet Pan Fitting

1. Prepare the pipes as advised (cutting of the flush pipe and pan connector may be required).
2. Add a small amount of lubricant (washing up liquid) to the seals on the pipes to assist with fitting, then push the toilet up to the finished wall / WC unit, with the pipes fully connected.

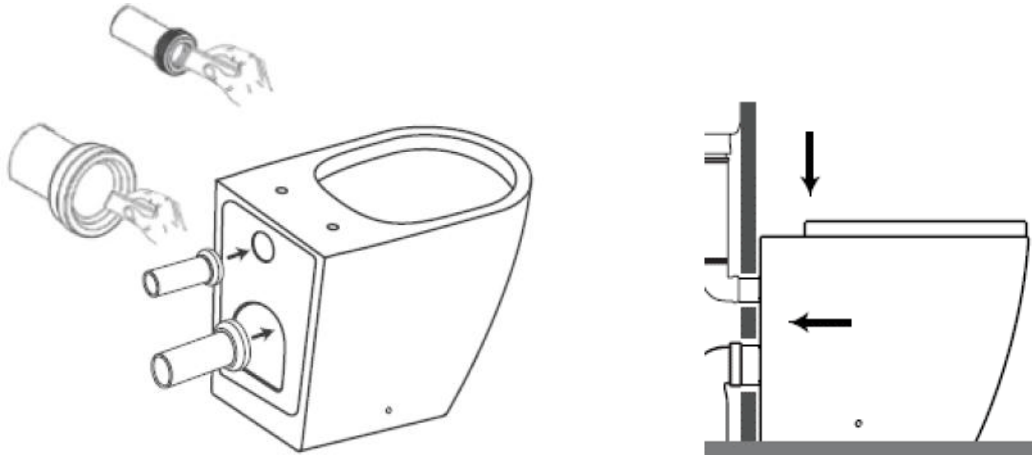

3. Ensure that the toilet pan is level and backed fully against the wall / WC unit, then mark on the outer edge of the pan (at both sides), align with each fixing hole located in the side wall of the toilet pan.

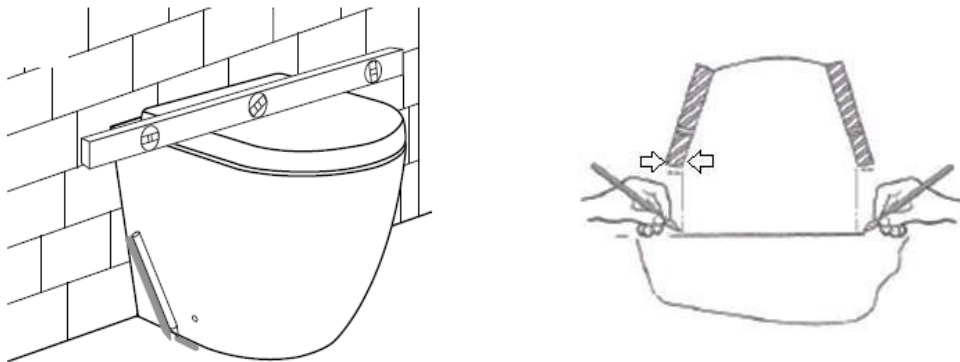

4. Remove the pan from the location, turn over, then measure the thickness of the toilet side wall and make another mark in from the original mark, and in line with the fixing hole, as shown below. Repeat on the other side.

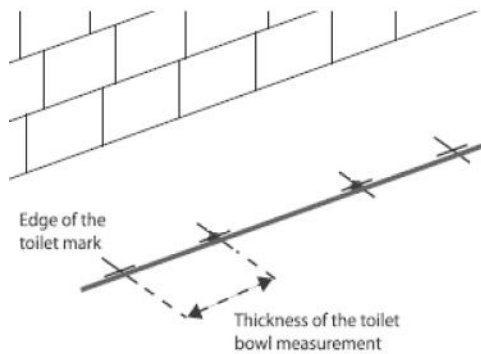

5. If using the 'L' shaped bracket assembly, place the front edge of the bracket on the inside mark, then mark the screw hole position to secure the bracket to the floor. Repeat on the other side.

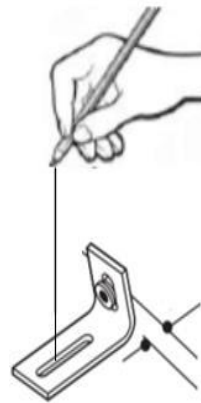

Please Note: For toilets which secure through the toilet directly into the floor, the L shaped bracket is not used

6. Remove the brackets and drill the holes, ensuring that no pipes or cables can be damaged.

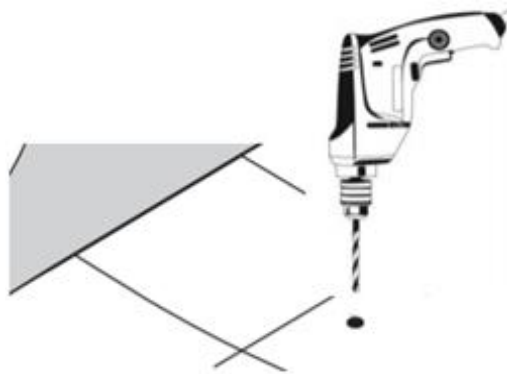

7. If fitting into a solid floor, you will need to install the screw plugs and tap flush to the floor, then place the brackets over the drilled holes/plugs and insert the screws and washers through the brackets and secure into position.

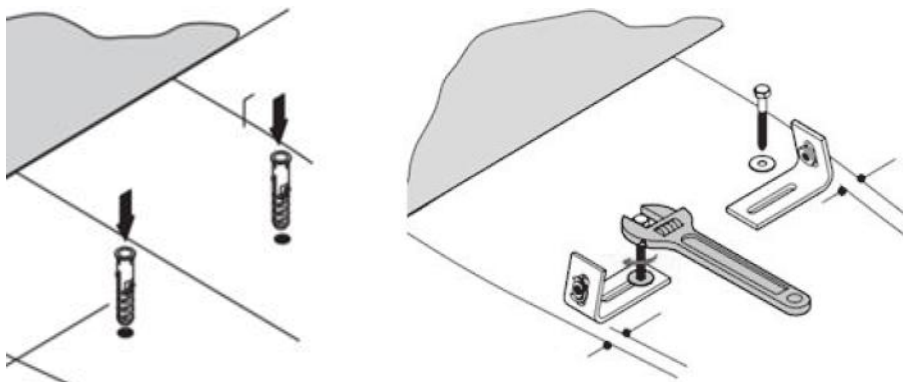

Please note: Depending on the specification, this may be a screwdriver slot, not a spanner fitting

8. After securing the brackets, re-fit the toilet pan and push it back fully against the wall / WC unit, so that the fixing holes align with the floor brackets.

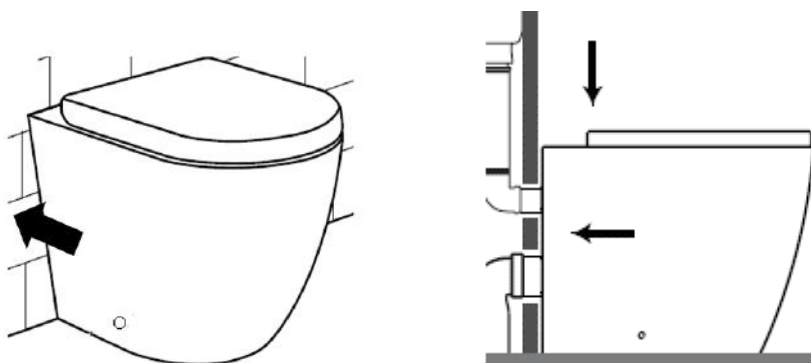

9. Once aligned, secure the toilet pan into position using the fixings provided, do not overtighten. Finish by pushing on the screw covers.

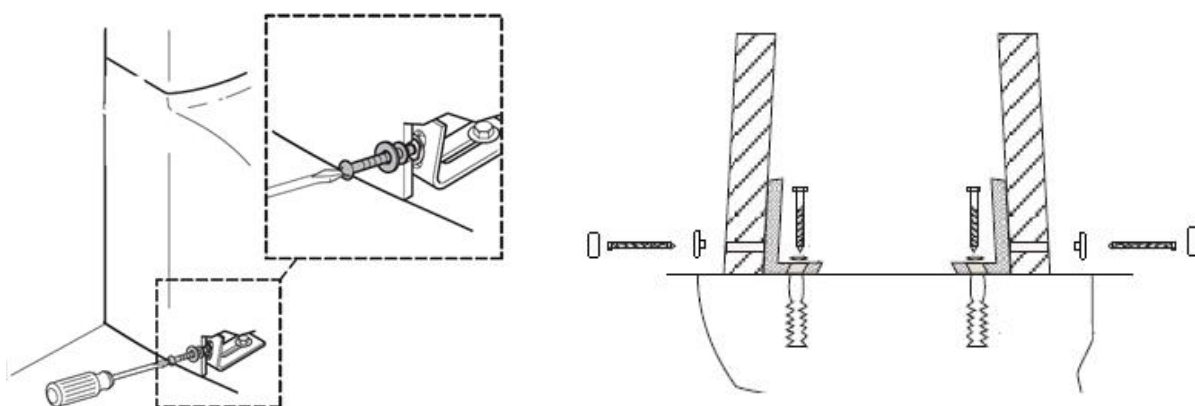

10. Once the installation is completed, a small bead of silicone can be applied around the bottom edge of the toilet pan.

Troubleshooting

Flush volume into the pan, not sufficient

1. Adjust the flush volume level on the syphon.
2. Check that the syphon is opening correctly.
3. If none of these resolve the issue replace the syphon.

Water running into the pan continually after flushing

1. Establish if the water level in the cistern is reaching the overflow on the syphon, if it does reach the overflow adjust the inlet valve.
2. If this continues, replace the inlet valve
3. If the water level does not reach the overflow on the syphon, remove the top section of the syphon and check the washer for damage.
4. If the washer is damaged then replace.

Maintenance

All of the maintenance measures resulting from troubleshooting above requires you to access the internals of the cistern tank and for the water supply to be turned off. Please refer to the instruction guide supplied with your cistern for further guidance.

Please note: Before carrying out any internal maintenance, turn off the water supply

Cleaning

To maintain the surface finish of your product, wipe clean after every use, using a clean damp cloth, a mild detergent mixture can be used. Do not use abrasive cleaning agents or materials which can strip and scratch the surface; the use of these agents or materials can invalidate your guarantee.

For more information

- visit betterbathrooms.com
- email customerservices@buyitdirect.co.uk
- call 0330 390 3062
- write to Trident Business Park, Neptune Way, Huddersfield, HD2 1UA

better 
bathrooms

Part of the BuyItDirect Group

USER MANUAL



Thank you for choosing Better Bathrooms.
Please read this manual before installing your product
and keep for future reference.

**better
bathrooms**

BeBa_17298 - Top Fix Soft Close Toilet Seat

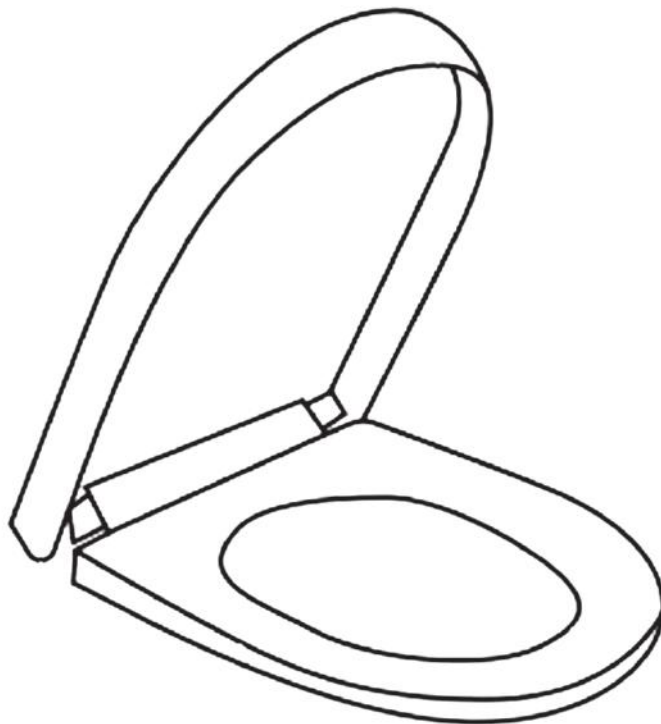

Please note: Image is for illustrative purposes only and may differ slightly to the actual product

- **Single-person assembly**
- **Tools required**
- **We always recommend using professional tradespeople to install your product**

V1_30.08.22

Congratulations on your purchase

And welcome to our growing gang of savvy shoppers

We're on a mission to bring you extraordinary bathroom products, for less. From modern to traditional style ceramics, plus the gorgeous fixtures, fittings and furniture to match. So, you can fall in love with your space every single day.

As one of the UK's largest independent bathroom stores, we've received countless awards; including the National Business Awards UK, the Digital Entrepreneur Awards and being placed on The Sunday Times Fast Track 100.

We hope your new product goes above and beyond your expectations. However, should any problems occur, please:

- log in to your account and contact our customer services team via your self-serve portal – betterbathrooms.com/CustomerAccount/Login
- contact us via betterbathrooms.com/content/contact-us

Important information

- Please read these instructions thoroughly and retain for future reference
- Manufactured to BS EN 1254 – Specification for WC seats (plastics)

Parts

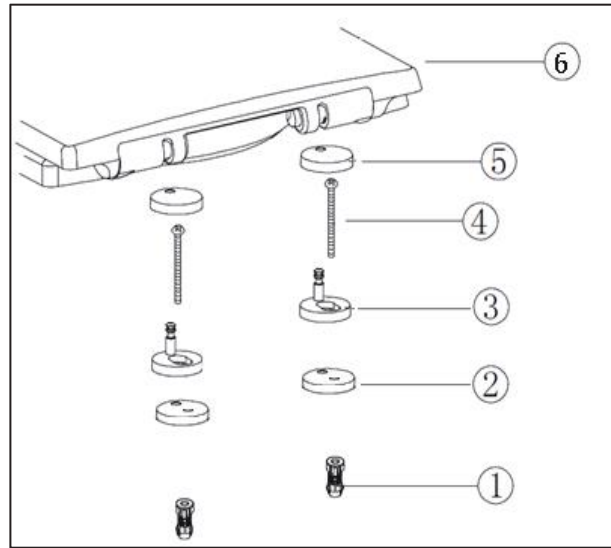

Please note that Parts are for illustrative purposes only and may differ slightly to the actual product

1. Expanding Plug
2. Gasket
3. Fitting Peg
4. Fixing Screw
5. Fitting Cover
4. Seat/Lid Assembly

Tools required

Screwdriver

Installation

1. Push the expanding plugs (part 1) into the holes on the toilet pan then place the gaskets (part 2) between fitting pegs (part 3) and toilet pan. Next, place the long screws (part 4) through the fitting pegs and gaskets and screw into the expanding plug (part 1).

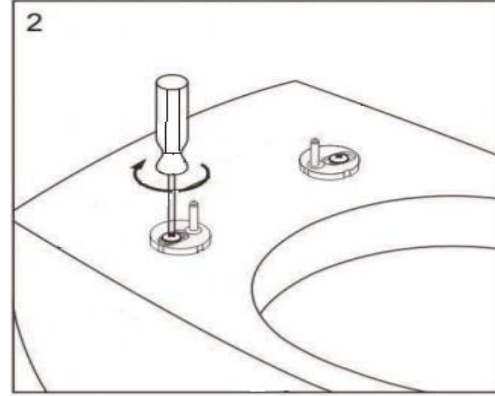
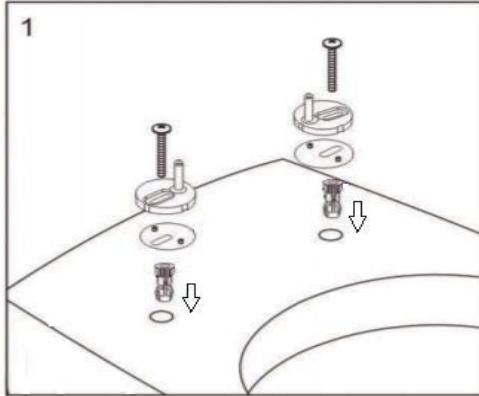

Please note: Fit the screws loosely and do not fully tighten at this stage

2. Turn the fittings on the toilet so that they align with the holes on the seat, then push the seat onto the pegs until it clicks into place. Gently move the seat so that it aligns on the toilet pan.

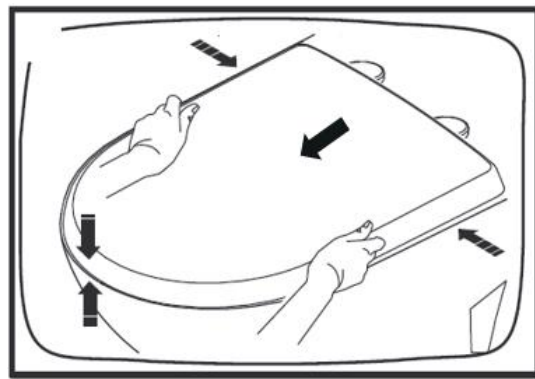
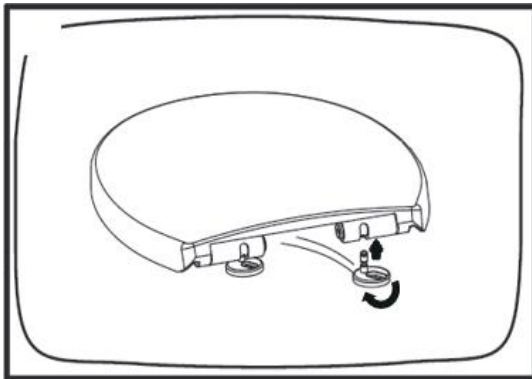

3. Once the seat is aligned, tighten the screws into the fittings (as below) then once the seat is secured, remove it by pressing both on the rear and lifting away.

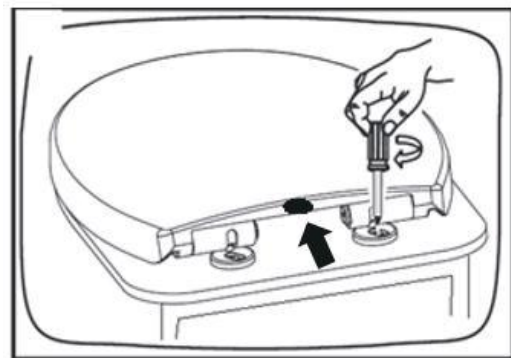
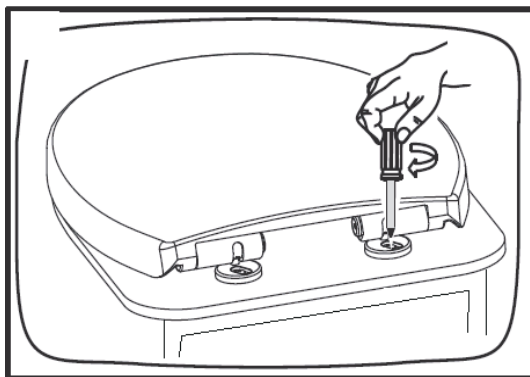

4. Place the fitting covers over the fixed fittings then push the seat onto the fitting pegs and click into position

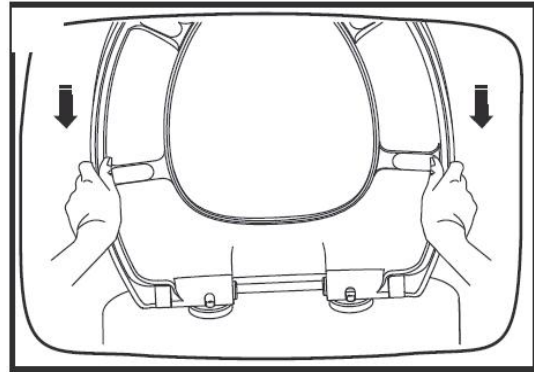
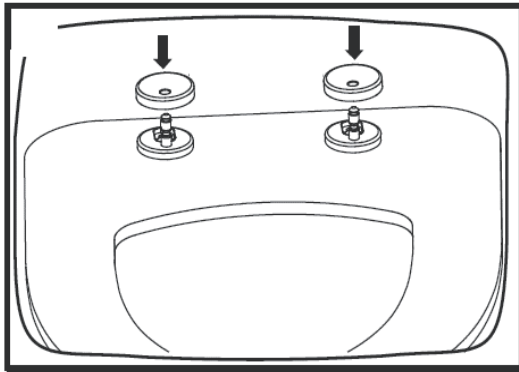

Using

During use do not force the seat closed as this will damage the soft close mechanism.

Pull the seat and/or lid towards you slightly until it reaches the point at which it will fall under its own weight, then release.

Do not stand on the toilet seat.

Cleaning

To maintain the surface of your product, wipe with a clean damp cloth and wipe dry, do not use any abrasive cleaning agents or materials.

It is recommended to wipe the seat and fittings on a regular basis.

Troubleshooting

Seat becomes loose after a period of use

Remove the seat and re-tighten the fittings.

Soft close mechanism stops working

The mechanism cannot be replaced, replace the seat and lid, however, the fittings can remain fitted. Removal of seat/lid is advised in Maintenance (below).

Seat is short or overhangs the toilet pan

Align the seat lid with the front edge of the toilet pan, the fittings are adjustable.

Maintenance

- To remove the seat/lid, press the button at the rear of the seat and pull the seat/lid away from the fitting pegs. When replacing ensure it clicks into place.

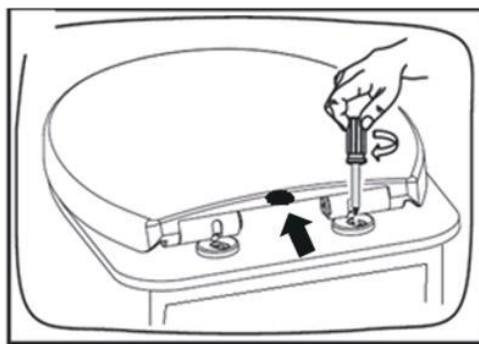

- To access the fixing screws, remove the lid/seat as above, then pull off the covers.

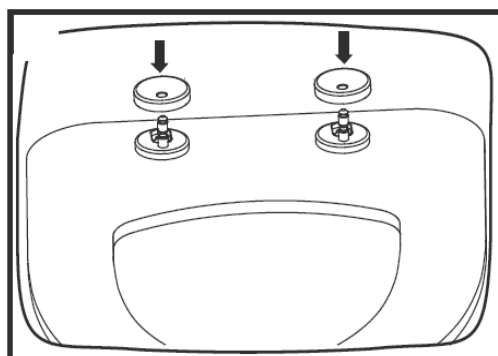

For more information

- visit betterbathrooms.com
- email customerservices@buyitdirect.co.uk
- call 0330 390 3062
- write to Trident Business Park, Neptune Way, Huddersfield, HD2 1UA

**better
bathrooms**

Part of the BuyItDirect Group